

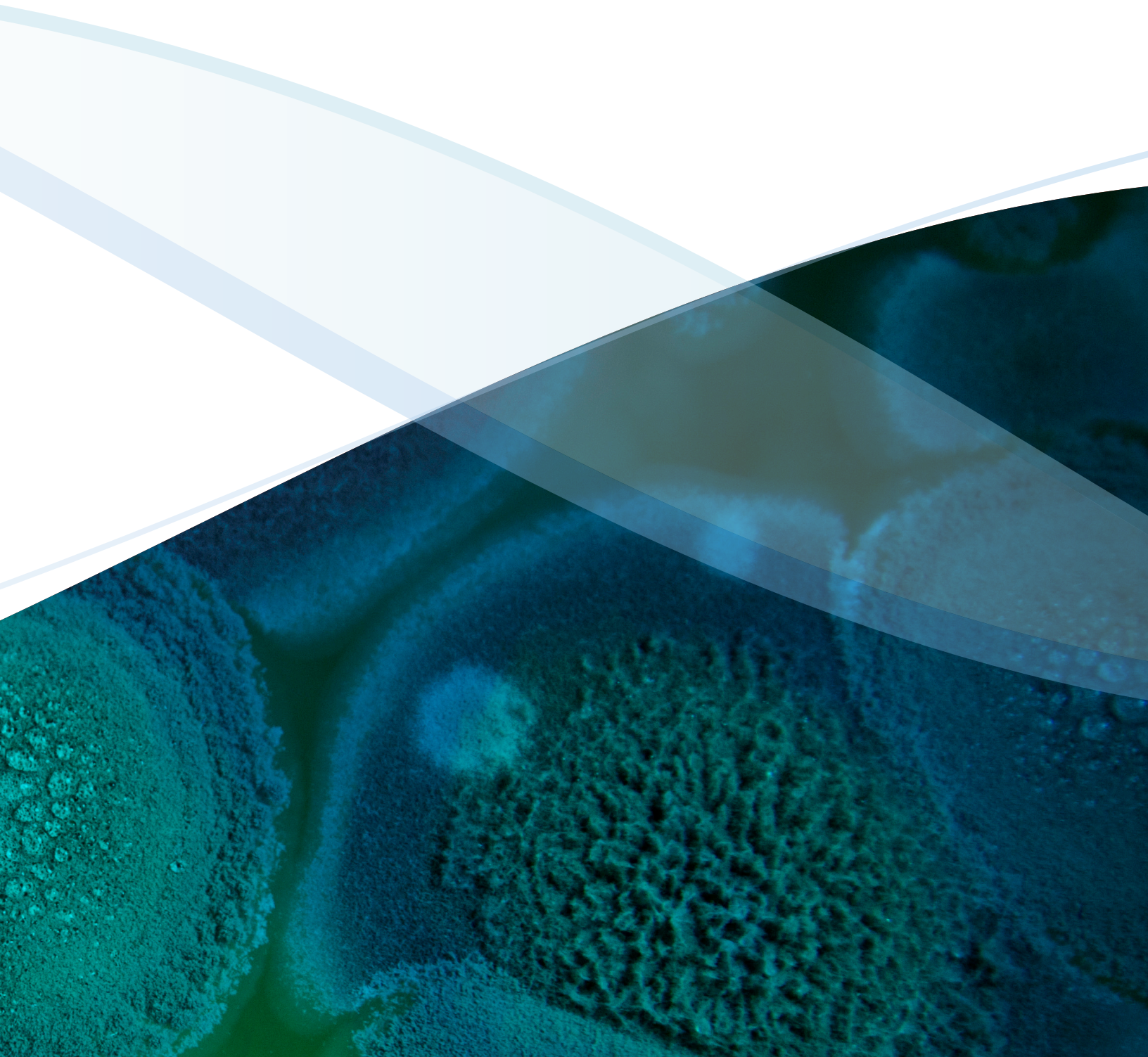

# Synthetic Biology Solutions User Guide

Biological Systems Design and Development



# Table of Contents

---

Product Overview .....	3
Application Examples .....	4
Frequently Asked Questions.....	8
Product listing.....	9
References.....	10
Appendix .....	11

# PRODUCT OVERVIEW

The ATCC Synthetic Biology Yeast Tool Kit, which was developed by the Weiss laboratory at MIT, is based on a framework<sup>1</sup> designed to assemble multiple transcriptional units (TUs) for the flexible delivery of genetic circuits in yeast. This approach combines advances in Gateway<sup>®</sup> recombination-based cloning strategies,<sup>2,3</sup> Gibson Assembly<sup>®</sup>,<sup>4,6</sup> and unique nucleotide sequences for determining the position of every TU to permit the development of genetic circuits comprising multiple promoter-gene pairs. The system operates in two stages (Figure 1): First, a single TU comprising a promoter-gene pair is generated via Gateway recombinae technology; and second, multiple coded TUs are positionally assembled together into a vector backbone using Gibson Assembly.

The initial design to full circuit construction takes approximately 4-7 days and does not require gel extractions or polymerase chain reactions, thus reducing potential mutation rates. Additionally, multiple TUs can be built in parallel, rather than sequentially or in a hierarchical reaction, allowing individual elements to be swapped with ease (e.g., changing a promoter to enable higher levels of expression or using a fluorescent protein color). As part of the tool kit, ATCC offers constitutive promoters, inducible promoters, transcriptional regulators, a selection marker, and two empty donor vectors for investigators to build additional promoters and genes for assembly. Moreover, the necessary backbones to create up to 7 single TUs and transform yeast with site-specific integration, low-copy, or high-copy vectors are available (Table 2).

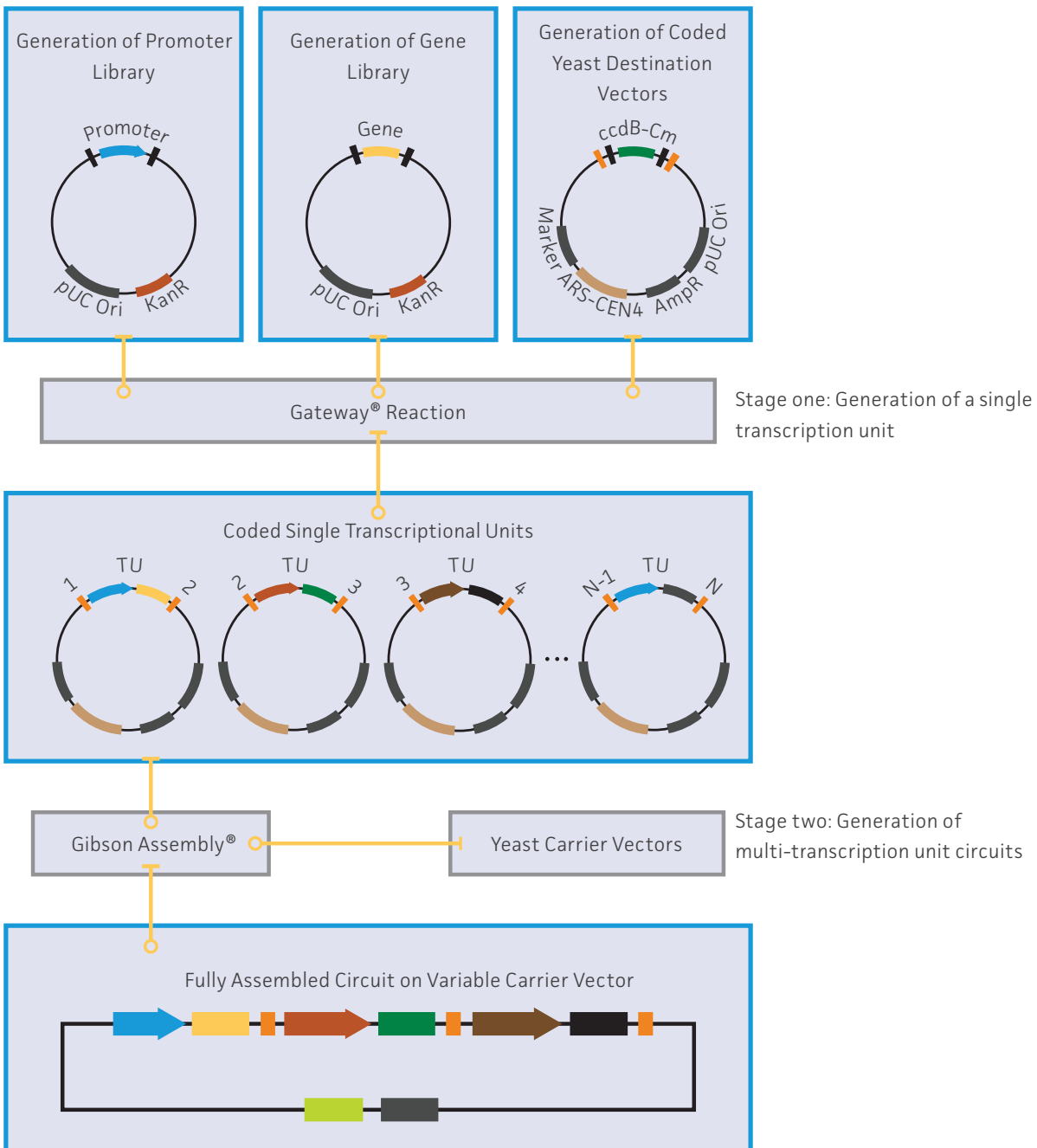

**Figure 1:** Schematic of the two-stage Gateway/Gibson Assembly strategy using ATCC Synthetic Biology Yeast Tool Kit components

# APPLICATION EXAMPLES

## Example 1: How to build a construct that enables constant ectopic expression of a single gene of interest

This construction demonstrates how to express a green fluorescent protein (GFP) under the control of a strong yeast promoter (YPD1). It involves two Gateway reactions and one Gibson Assembly reaction (Figure 2). Before performing the Gateway and Gibson Assembly reactions, the GFP gene should first be cloned into the entry vector pENTR\_L1L2\_DONR1 (ATCC® [SB-1013™](#)) to generate the construct pENTR\_L1L2\_GFP. Additional detailed information on how to build a pENTR\_L1L2\_Gene construct can be viewed in the Appendix.

### STAGE 1: GATEWAY REACTION

- 1 Each TU is assembled into a destination vector using the Gateway LR reaction, according to manufacturer's instructions<sup>5</sup>.
  - a In the first TU assembly, pDEST-12y (ATCC® [SB-1000™](#)), pENTR\_L4R1\_YPD1 (ATCC® [SB-1041™](#)), and the pre-built pENTR\_L1L2\_GFP construct are required.
  - b In the second TU assembly, pDEST-23y (ATCC® [SB-1001™](#)), pENTR\_L4R1\_TEF2 (ATCC® [SB-1044™](#)), and pENTR\_L1L2\_KanMX (ATCC® [SB-1006™](#)) are required.
- 2 After performing the Gateway reaction, a portion of the reaction mixture is transformed into ccdB-sensitive, competent *E. coli* cells under antibiotic selection using ampicillin.
- 3 Assembly clones containing the TU of interest can be verified via restriction mapping or sequencing.

### STAGE 2: GIBSON ASSEMBLY

- 1 Assembly requires four genetic parts: Two TUs, a PacI-linearized low-copy carrier, and a PCR-amplified adapter containing the kanamycin resistance gene (Kan). Detailed information on the Gibson Assembly reaction can be viewed in the manufacturer's instruction manual<sup>6</sup>.
  - a Each TU built using the Gateway reaction, together with the two unique 45 bp adjacent sequences, can be released from the vector using the restriction enzyme I-SceI.
  - b The low-copy carrier pCarrier 3 (416) (ATCC® [SB-1004™](#)) is digested via the restriction enzyme PacI to linearize the vector, resulting in two unique 45 bp sequences (1 and X) present at the ends of the linearized vector.
  - c The Kan adapter is PCR-amplified using the primer pair Seq3-KanF and KanR-SeqX (Table 1); any of the ATCC pENTR entry vectors (e.g., ATCC® [SB-1041™](#)) can be used as a DNA template. The PCR product will contain unique 45 bp sequences (3 and X) at the ends of the DNA fragment.
- 2 The assembly order is determined by the unique 45 bp sequences (1, 2, 3, and X) located at the ends of each fragment.
- 3 After complete assembly of the construct in *E. coli*, the plasmid is then isolated and transformed into yeast under antibiotic selection using G418.
- 4 Following successful assembly and yeast transformation, the expression of GFP can be analyzed by cytometry.

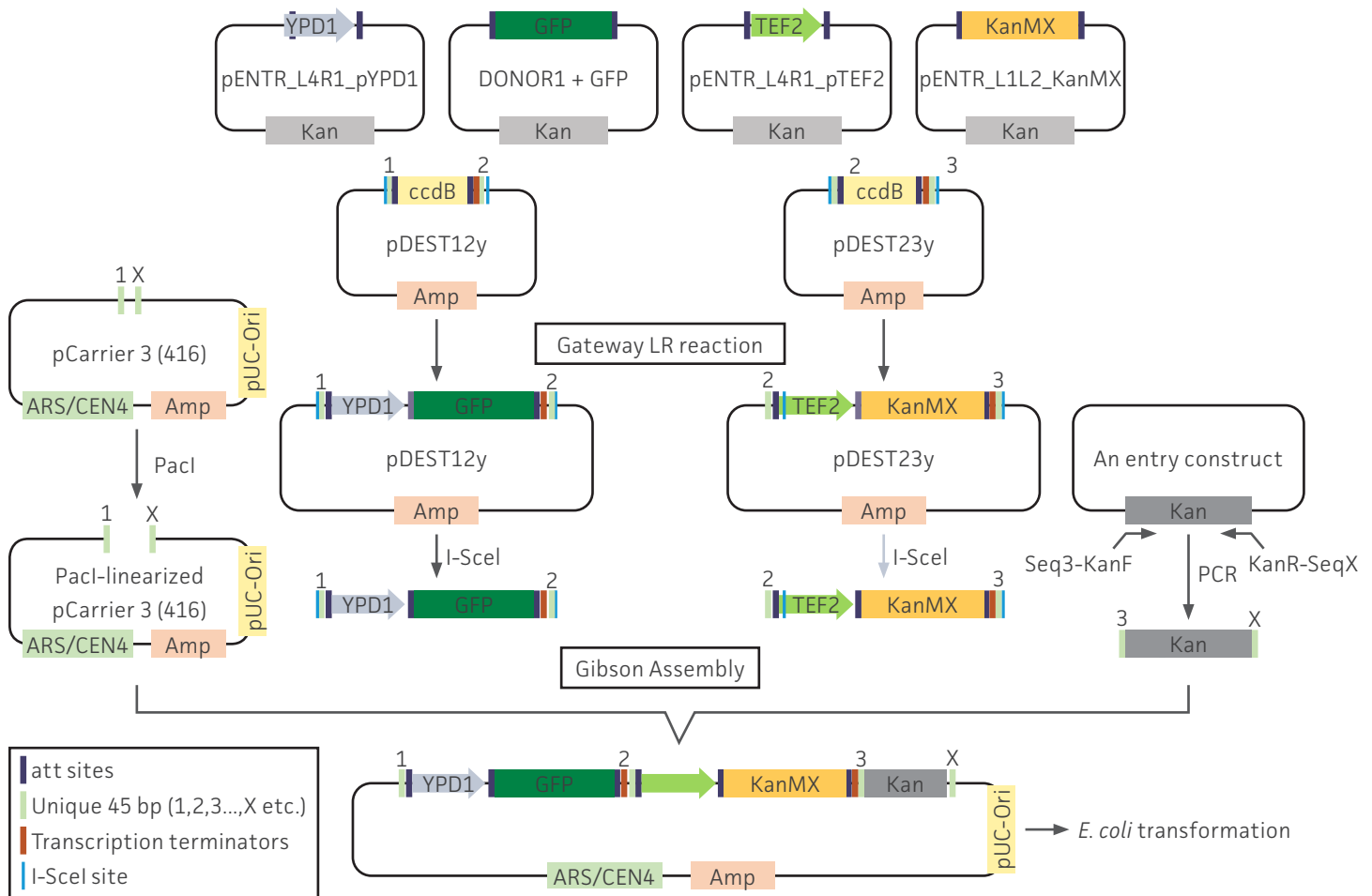

**Figure 2:** Schematic of how to build a construct that enables constant ectopic expression of a single gene of interest

**Table 1:** PCR primers for generating SeqN – SeqX adapters

Name	Sequence*
KanR-SeqX	GGTTAGGCGACTGTTATAACTTACCTCTGTAATACTAGTGATACCATGAGCTTGCGCCGT
Seq1-KanF	GGTTTACCGAGCTCTTATTGGTTTTCAAACCTCATTGACTGTGCCGGCCCGTGTCTCAA
Seq2-KanF	GGTGC GTTTTTATGCTTGTAGTATTGTATAATGTTTTAAGATCTTGCCCGTGTCTCAA
Seq3-KanF	GGTCTAATACCAATCTCTCGTCTTATCCAGATGTTTTATACGCCCTGGCCCGTGTCTCAA
Seq4-KanF	GGTGAATTCCTTATGTGAGTGTAAGGCGAGGCGAGTTTGTCCCTGGCCCGTGTCTCAA
Seq5-KanF	GGTTGCTTGCAAAAGCAGTAATTGAAAGCACTCTCAAAGAATCCCTGGCCCGTGTCTCAA
Seq6-KanF	GGTAGATAAGTTGATTAGCCATAAAATATTGTTCCGTGACCCCTGGCCCGTGTCTCAA
Seq7-KanF	GGTTCTGAGTCACGGCTTCATTGGCATTCCGTACAACGAACGTCTGGCCCGTGTCTCAA
Seq8-KanF	GGTCCTCAGAGAGCCTATAGCGGTAACAAACACCATGCATCCCTGGCCCGTGTCTCAA

\*The unique 45 bp codes are highlighted in bold

### Example 2: How to build an inducible expression system that is integrated into the genome

This construction demonstrates how to build an inducible expression system integrated into the genome that comprises a single gene (e.g., a yellow fluorescent protein [YFP]) mediated by the antibiotic 2,4-diacetylphloroglucinol (DAPG) and the transcriptional repressor PhIF (Figure 3A). It involves three Gateway reactions and one Gibson Assembly reaction. Before performing the Gateway and Gibson Assembly reactions, a reporter gene (e.g., YFP) should first be cloned into the entry vector pENTR\_L1L2\_DONR1 (ATCC® SB-1013™) to generate the construct pENTR\_L1L2\_YFP. Additional detailed information on how to build a pENTR\_L1L2\_Gene construct can be viewed in the Appendix.

## STAGE 1: GATEWAY REACTION

- 1 Three TUs are built in destination vectors using the Gateway reaction, according to manufacturer's instructions<sup>5</sup>.
  - a In the first TU assembly, pDEST-12y (ATCC® [SB-1000™](#)), pENTR\_L4R1\_YPD1 (ATCC® [SB-1041™](#)), and pENTR\_L1L2\_PhIF ([SB-1032™](#)) are required.
  - b In the second TU assembly, pDEST-23y (ATCC® [SB-1001™](#)), pENTR\_L4R1\_GPD-PhIF (ATCC® [SB-1070™](#)), and pENTR\_L1L2\_YFP are required.
  - c In the third TU assembly, pDEST-34y (ATCC® [SB-1002™](#)), pENTR\_L4R1\_TEF2 (ATCC® [SB-1044™](#)), and pENTR\_L1L2\_KanMX (ATCC® [SB-1006™](#)) are required.
- 2 After performing the Gateway reaction, a portion of the reaction mixture is transformed into ccdB-sensitive, competent *E. coli* cells under antibiotic selection using ampicillin.
- 3 Assembly clones containing the TU of interest can be verified via restriction mapping or sequencing.

## STAGE 2: GIBSON ASSEMBLY

- 1 Assembly requires five genetic parts: Three TUs, a PCR-amplified Kan-resistant adapter, and a PacI-linearized integrating carrier. Detailed information on the Gibson Assembly reaction can be viewed in the manufacturer's instruction manual<sup>6</sup>.
  - a Each TU built in a destination vector, together with two unique 45 bp adjacent sequences, can be released from the vector using the restriction enzyme I-SceI.
  - b The integrating carrier pCarrier 8 (integ) (ATCC® [SB-1005™](#)) is digested via the restriction enzyme PacI to linearize the vector, resulting in two unique 45 bp sequences (1 and X) present at the ends of the linearized vector.
  - c The Kan-resistant adapter is PCR-amplified using the primer pair Seq4-KanF and KanR-SeqX (Table 1); any of the ATCC pENTR entry vectors (e.g., ATCC® [SB-1041™](#)) can be used as a DNA template. The PCR product will contain unique 45 bp sequences (4 and X) at the ends of the DNA fragment.
- 2 The assembly order is determined by the unique 45 bp sequences (1, 2, 3, 4, and X) located at the ends of each fragments.
- 3 After complete assembly of the construct in *E. coli*, the plasmid is then isolated and digested with I-SceI to release the construct together with the two adjacent homothallic (HO) fragments (~480 bp) for yeast transformation. Two HO sequences flanking the construct mediate HO locus integration via homologous recombination (Figure 3B).

A

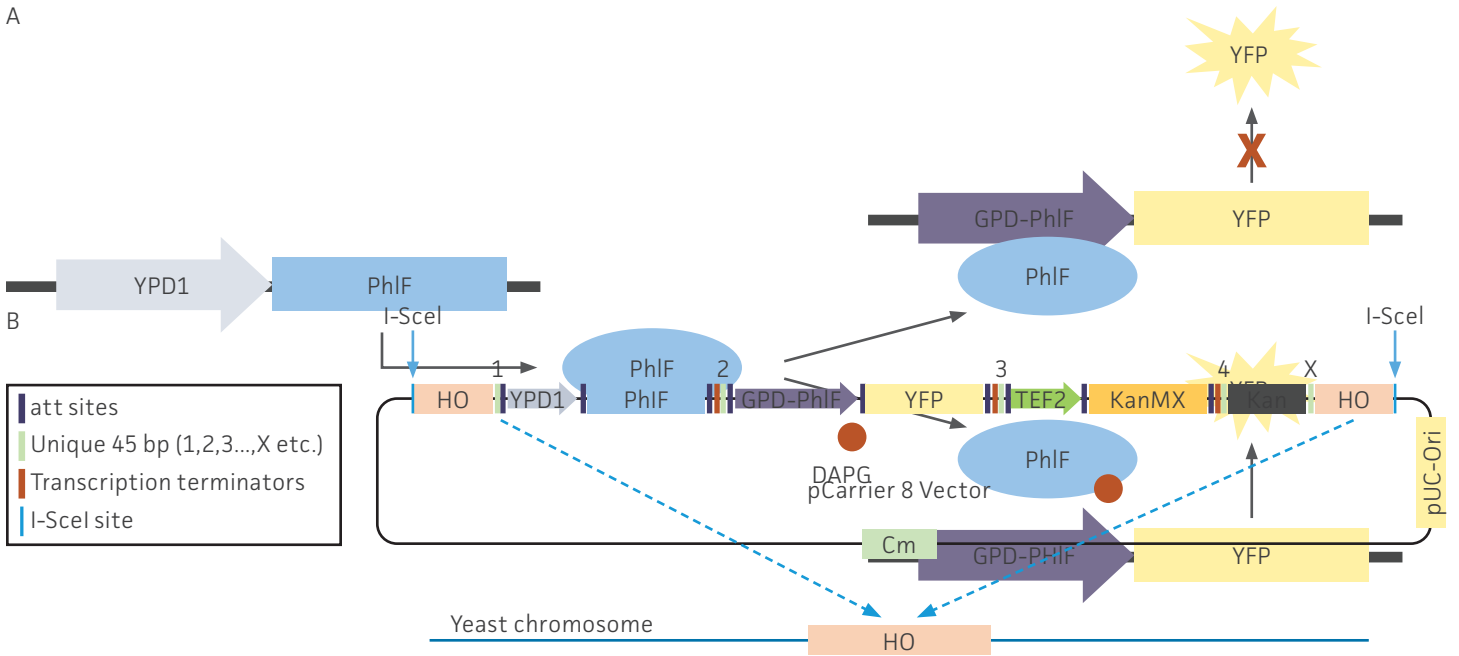

**Figure 3: Schematic of how to build a DAPG-inducible circuit that is integrated into the genome.** A) Diagram of the DAPG/PhIF system using YFP as a reporter. The transcriptional regulator PhIF binds to the PhIF operator region of the synthetic promoter GPD-PhIF in the absence of DAPG; this binding inhibits YFP expression. The addition of DAPG, which binds to the PhIF regulator, results in the dissociation of PhIF from the promoter; this leads to the steady expression of YFP. B) Diagram of a gene circuit assembled in an integration vector. Following the complete assembly of three TUs along with the Kan adapter into the integration vector, the gene circuit flanked by two HO sequences is released from the vector via the I-SceI restriction enzyme. The gene circuit then integrates into the HO locus in the yeast chromosome via homologous recombination.

# FREQUENTLY ASKED QUESTIONS

## 1 What if I don't get any colonies after the transformation of TUs built using the Gateway reaction?

Ensure the competency of the host cells and that plates are supplemented with the correct antibiotic by using a pUC19-Amp control with each transformation. For each Gateway reaction, verify that all necessary genetic parts were added; because the reaction results in recombination, missing any one of these components will result in the lack of a successful product.

## 2 What if I don't get any colonies after the transformation of Gibson Assembly products?

Ensure cell competency of the host cells and that plates are supplemented with the correct antibiotics (CM + Kan) by using a control with each Gibson Assembly reaction. For Gibson Assembly reactions, verify that all necessary genetic parts were added in equimolar ratios and that the Gibson mix is fresh (most commercial mixes include a positive control).

## 3 What is the purpose of the adapter sequence?

Because each carrier vector has a defined Sequence 1 and Sequence X flanking 45 bp regions, but individual networks may range in size from 1 to 7 parts, the adapter bridges the varying sizes to a single carrier. Additionally, by including a kanamycin resistance gene, the dual selection of carrier and adapter improve the final success rate of finding a correct Gibson clone.

## 4 How do I generate my own ENTR promoter or gene plasmids for use?

As part of the tool kit, we have included two DONR plasmids that have blue-white screening capabilities and Golden Gate cloning compatibility. Simply PCR or synthesize the promoter or gene of interest as described in the Appendix and follow a single-step cloning reaction.



# PRODUCT LISTING

**Table 2: ATCC® Synthetic Biology Yeast Tool Kit**

ATCC® No.	Product Name	Product Description
<a href="#">SB-1000™</a>	pDEST-12y	Gateway destination vector-12
<a href="#">SB-1001™</a>	pDEST-23y	Gateway destination vector-23
<a href="#">SB-1002™</a>	pDEST-34y	Gateway destination vector-34
<a href="#">SB-1003™</a>	pDEST-45y	Gateway destination vector-45
<a href="#">SB-1015™</a>	pDEST-56y	Gateway destination vector-56
<a href="#">SB-1016™</a>	pDEST-67y	Gateway destination vector-67
<a href="#">SB-1017™</a>	pDEST-78y	Gateway destination vector-78
<a href="#">SB-1004™</a>	pCarrier 3 (416)	Yeast low copy vector
<a href="#">SB-1024™</a>	pCarrier 7 (426)	Yeast high copy vector
<a href="#">SB-1005™</a>	pCarrier 8 (integ)	Yeast integration vector
<a href="#">SB-1006™</a>	pENTR_L1L2_KanMX	Entry vector carrying a yeast selection marker
<a href="#">SB-1013™</a>	pENTR_L1L2_DONR1	Gateway empty entry vector-1
<a href="#">SB-1014™</a>	pENTR_L4R1_DONR2	Gateway empty entry vector-2
<a href="#">SB-1008™</a>	pENTR_L4R1_pHOG1	Entry vector carrying yeast constitutive promoter, pHOG1
<a href="#">SB-1035™</a>	pENTR_L4R1_pHOT1	Entry vector carrying yeast constitutive promoter, pHOT1
<a href="#">SB-1036™</a>	pENTR_L4R1_pSSRE	Entry vector carrying yeast constitutive promoter, pSSRE
<a href="#">SB-1038™</a>	pENTR_L4R1_pTR-SSRE	Entry vector carrying yeast constitutive promoter, pTR-SSRE
<a href="#">SB-1041™</a>	pENTR_L4R1_pYPD1	Entry vector carrying yeast constitutive promoter, pYPD1
<a href="#">SB-1044™</a>	pENTR_L4R1_pTEF2	Entry vector carrying yeast constitutive promoter, pTEF2
<a href="#">SB-1104™</a>	pENTR_L4R1_pCYC1MIN	Entry vector carrying yeast constitutive promoter, pCYC1MIN
<a href="#">SB-1105™</a>	pENTR_L4R1_pSKN7	Entry vector carrying yeast constitutive promoter, pSKN7
<a href="#">SB-1046™</a>	pENTR_L4R1_pGAL1	Entry vector carrying yeast inducible promoter, pGAL1
<a href="#">SB-1050™</a>	pENTR_L4R1_pTETO7	Entry vector carrying a tetracycline response element (TRE)
<a href="#">SB-1055™</a>	pENTR_L4R1_BetI-pCYC1MIN	Entry vector carrying a synthetic inducible promoter, BetI-pCYC1MIN
<a href="#">SB-1056™</a>	pENTR_L4R1_BM3R1-pCYC1MIN	Entry vector carrying a synthetic inducible promoter, BM3R1-pCYC1MIN
<a href="#">SB-1059™</a>	pENTR_L4R1_LitR-pCYC1MIN	Entry vector carrying a synthetic inducible promoter, LitR-pCYC1MIN
<a href="#">SB-1060™</a>	pENTR_L4R1_PhIF-pCYC1MIN	Entry vector carrying a synthetic inducible promoter, PhIF-pCYC1MIN
<a href="#">SB-1061™</a>	pENTR_L4R1_QacR-pCYC1MIN	Entry vector carrying a synthetic inducible promoter, QacR-pCYC1MIN
<a href="#">SB-1066™</a>	pENTR_L4R1_pGPD-BM3R1	Entry vector carrying a synthetic repressible promoter, pGPD-BM3R1
<a href="#">SB-1069™</a>	pENTR_L4R1_pGPD-LitR	Entry vector carrying a synthetic repressible promoter, pGPD-LitR
<a href="#">SB-1070™</a>	pENTR_L4R1_pGPD-PhIF	Entry vector carrying a synthetic repressible promoter, pGPD-PhIF
<a href="#">SB-1071™</a>	pENTR_L4R1_pGPD-QacR	Entry vector carrying a synthetic repressible promoter, pGPD-QacR
<a href="#">SB-1031™</a>	pENTR_L1L2_rtTA	Entry vector carrying a regulator, rtTA (reverse tetracycline-controlled transactivator)
<a href="#">SB-1032™</a>	pENTR_L1L2_PhIF	Entry vector carrying a TetR homolog-based repressor, PhIF
<a href="#">SB-1086™</a>	pENTR_L1L2_BM3R1	Entry vector carrying a TetR homolog-based repressor, BM3R1
<a href="#">SB-1089™</a>	pENTR_L1L2_LitR	Entry vector carrying a TetR homolog-based repressor, LitR
<a href="#">SB-1090™</a>	pENTR_L1L2_QacR	Entry vector carrying a TetR homolog-based repressor, QacR
<a href="#">SB-1094™</a>	pENTR_L1L2_BetI-VP64	Entry vector carrying a TetR homolog-based repressor, BetI-VP64
<a href="#">SB-1095™</a>	pENTR_L1L2_BM3R1-VP64	Entry vector carrying a TetR homolog-based repressor, BM3R1-VP64
<a href="#">SB-1098™</a>	pENTR_L1L2_LitR-VP64	Entry vector carrying a TetR homolog-based repressor, LitR-VP64
<a href="#">SB-1099™</a>	pENTR_L1L2_PhIF-VP64	Entry vector carrying a TetR homolog-based repressor, PhIF-VP64
<a href="#">SB-1100™</a>	pENTR_L1L2_QacR-VP64	Entry vector carrying a TetR homolog-based repressor, QacR-VP64
<a href="#">SB-2000™</a>	Basic Yeast Synthetic Biology Tool Kit	The basic tool kit consists of 4 destination vectors ( <a href="#">SB-1000™</a> , <a href="#">SB-1001™</a> , <a href="#">SB-1002™</a> , and <a href="#">SB-1003™</a> ), 3 carrier vectors ( <a href="#">SB-1004™</a> , <a href="#">SB-1005™</a> , and <a href="#">SB-1024™</a> ), 2 empty entry vectors of the Gateway system ( <a href="#">SB-1013™</a> and <a href="#">SB-1014™</a> ), a Kanamycin/G418-resistant gene ( <a href="#">SB-1006™</a> ), 4 yeast constitutive promoters ( <a href="#">SB-1008™</a> , <a href="#">SB-1035™</a> , <a href="#">SB-1041™</a> , <a href="#">SB-1105™</a> ), and an inducible promoter ( <a href="#">SB-1046™</a> )
<a href="#">SB-2001™</a>	rtTA/TETO7 activation pair	TRE promoter (ATCC® <a href="#">SB-1050™</a> ) and its regulator rtTA (ATCC® <a href="#">SB-1031™</a> )

ATCC® No.	Product Name	Product Description
<a href="#">SB-2002™</a>	BetI activation pair (TetR Homolog)	Synthetic promoter BetI-pCYC1MIN (ATCC® <a href="#">SB-1055™</a> ) and its regulator BetI-VP64 (ATCC® <a href="#">SB-1094™</a> )
<a href="#">SB-2003™</a>	BM3R1 activation pair (TetR Homolog)	Synthetic promoter BM3R1-pCYC1MIN (ATCC® <a href="#">SB-1056™</a> ) and its regulator BM3R1-VP64 (ATCC® <a href="#">SB-1095™</a> )
<a href="#">SB-2004™</a>	LitR activation pair (TetR Homolog)	Synthetic promoter LitR-pCYC1MIN (ATCC® <a href="#">SB-1059™</a> ) and its regulator LitR-VP64 (ATCC® <a href="#">SB-1098™</a> )
<a href="#">SB-2005™</a>	PhIF activation pair (TetR Homolog)	Synthetic promoter PhIF-pCYC1MIN (ATCC® <a href="#">SB-1060™</a> ) and its regulator PhIF-VP64 (ATCC® <a href="#">SB-1099™</a> )
<a href="#">SB-2006™</a>	QacR activation pair (TetR Homolog)	Synthetic promoter QacR-pCYC1MIN (ATCC® <a href="#">SB-1061™</a> ) and its regulator QacR-VP64 (ATCC® <a href="#">SB-1100™</a> )
<a href="#">SB-2008™</a>	BM3R1 repression pair (TetR Homolog)	Synthetic promoter pGPD-BM3R1 (ATCC® <a href="#">SB-1066™</a> ) and its regulator BM3R1 (ATCC® <a href="#">SB-1086™</a> )
<a href="#">SB-2009™</a>	LitR repression pair (TetR Homolog)	Synthetic promoter pGPD-LitR (ATCC® <a href="#">SB-1069™</a> ) and its regulator LitR (ATCC® <a href="#">SB-1089™</a> )
<a href="#">SB-2010™</a>	PhIF repression pair (TetR Homolog)	Synthetic promoter pGPD-PhIF (ATCC® <a href="#">SB-1070™</a> ) and its regulator PhIF (ATCC® <a href="#">SB-1032™</a> )
<a href="#">SB-2011™</a>	QacR repression pair (TetR Homolog)	Synthetic promoter pGPD-QacR (ATCC® <a href="#">SB-1071™</a> ) and its regulator QacR (ATCC® <a href="#">SB-1090™</a> )

## REFERENCES

- 1 Guye P, et al. Rapid, modular and reliable construction of complex mammalian gene circuits. *Nucleic Acids Res* 41: e156, 2013.
- 2 Alberti S, Gitler AD, Lindquist S. A suite of Gateway cloning vectors for high-throughput genetic analysis in *Saccharomyces cerevisiae*. *Yeast* 24: 913-919, 2007.
- 3 Katzen F. Gateway recombinational cloning: a biological operating system. *Expert Opin Drug Discov* 2(4): 571-589, 2007.
- 4 Gibson DG, et al. Enzymatic assembly of DNA molecules up to several hundred kilobases. *Nat Methods* 6(5): 343-345, 2009.
- 5 Invitrogen. Gateway Technology: A universal technology to clone DNA sequences for functional analysis and expression in multiple systems. Revision 1.0, 2003.
- 6 New England BioLabs, Inc. Gibson Assembly® Master Mix: Instruction Manual. Version 3.3, 2017.
- 7 New England BioLabs, Inc. NEB® Golden Gate Assembly Mix: Instruction Manal. Version 2.0, 2017.

# APPENDIX

## Generation of custom L1L2 gene ENTR or L4R1 promoter vectors using Golden Gate Assembly

We recommend using the Golden Gate cloning method to insert a gene or a promoter of interest into the pENTR\_L1L2\_DONR1 (ATCC® SB-1013™) or pENTR\_L4R1\_DONR2 (ATCC® SB-1014™) vectors, respectively (Figure 4). The vectors contain two Bsal sites flanking the LacZ alpha gene, enabling the selection of positive clones containing the insertion via screening on plates supplemented with X-Gal and IPTG. The gene or promoter can be generated by either gene synthesis or PCR. The ends of the DNA fragment should include a Bsal site and 4 bp overhang (Figure 4A). For the detailed Golden Gate assembly protocol, please follow the manufacturer's instruction7.

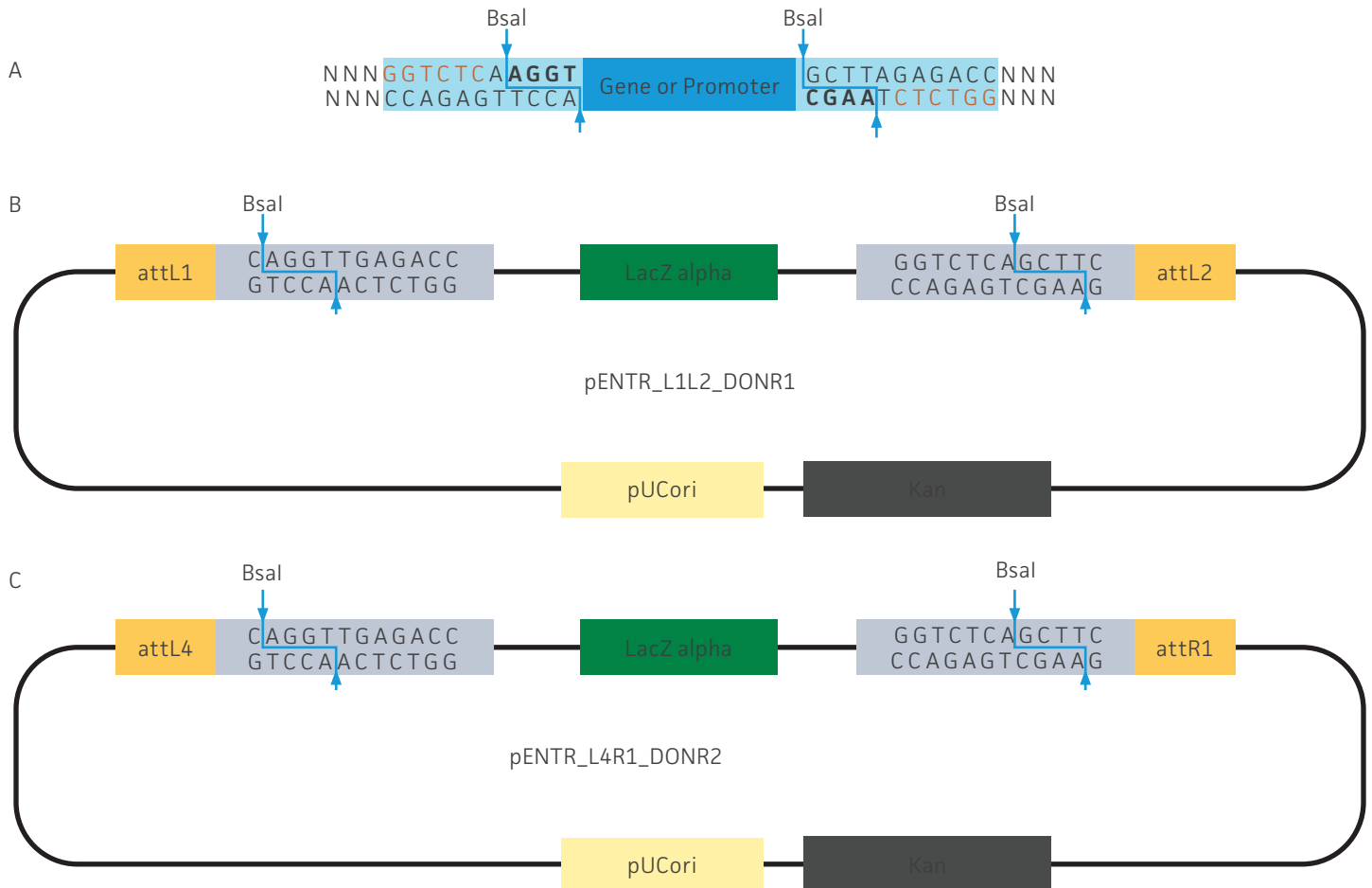

**Figure 4:** A) Sequence information for PCR-amplified or synthesized gene or promoter of interest. The ends of the DNA fragment should include a Bsal site (red) and a 4 bp overhang (bold). B) Genetic map for pENTR\_L1L2\_DONR1. C) Genetic map for pENTR\_L4R1\_DONR2.

### Disclaimers

This documentation is provided for laboratory research purposes only. While ATCC uses reasonable efforts to include accurate and up-to-date information, ATCC makes no warranties or representations as to its accuracy. Citations from scientific literature and patents are provided for informational purposes only. ATCC does not warrant that such information has been confirmed to be accurate. ATCC is not liable for any damages or injuries arising from receipt and/or use of this documentation. Please refer to the ATCC Material Transfer Agreement (MTA) for further details. The MTA is available on our Web site at [www.atcc.org](http://www.atcc.org).



10801 University Boulevard  
Manassas, Virginia 20110-2209



703.365.2700



703.365.2701



sales@atcc.org



www.atcc.org

**SBS-122021-v03**

©2022 American Type Culture Collection. The ATCC trademark and trade name, and any other trademarks listed in this publication are trademarks owned by the American Type Culture Collection unless indicated otherwise. Droplet Digital™ PCR is a trademark of Bio-Rad Laboratories, Inc. Gateway® is a registered trademark of Thermo Fisher Scientific. Invitrogen® is a registered trademark of Thermo Fisher Scientific. Thermo Fisher Scientific® is a registered trademark of Thermo Fisher Scientific. NEB® Golden Gate Assembly products are covered by one or more patents, trademarks, and/or copyrights owned or controlled by New England Biolabs, Inc. NEB® is a registered trademark of New England Biolabs, Inc. New England Biolabs® is a registered trademark of New England Biolabs, Inc. Gibson Assembly® is a registered trademark of Synthetic Genomics, Inc. Synthetic Genomics® is a registered trademark of Synthetic Genomics, Inc.

These products are for laboratory use only. Not for human or diagnostic use. ATCC products may not be resold, modified for resale, used to provide commercial services or to manufacture commercial products without prior ATCC written approval.